

## Τεχνικά χαρακτηριστικά

Διαστάσεις:	843x557x984h
Ισχύς:	800 Watt, 230V/50Hz
Ιπποδύναμη:	3/4 hp
Παραγωγή σε 24h αερόψυκτη:	122 kg
Freon:	R404a
Παγάκι τρύπα:	20 gr

Με ενσωματωμένη αποθήκη 50 kg

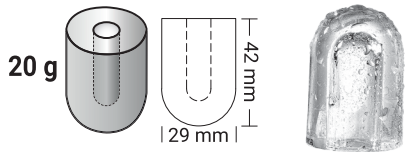

ΕΜΠΡΟΣΘΙΑ ΟΨΗ

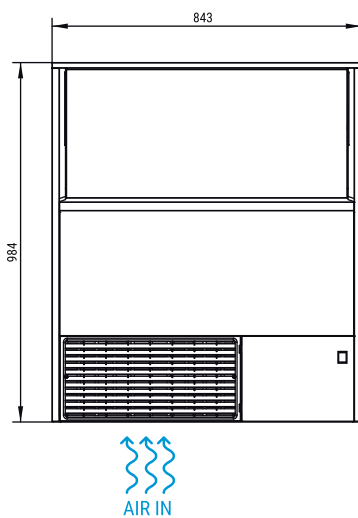

ΔΕΞΙΑ ΠΛΕΥΡΑ

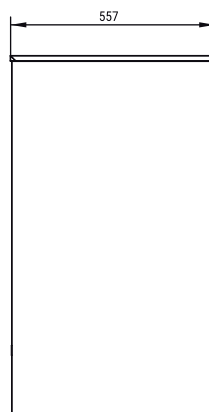



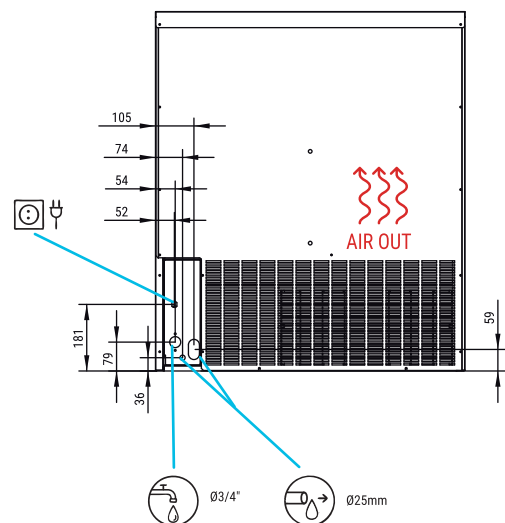



ΠΙΣΩ ΟΨΗ



## ΣΥΝΘΗΚΕΣ ΛΕΙΤΟΥΡΓΙΑΣ











### ΠΑΡΑΓΩΓΗ 50Hz

-  ±10%
-  5°C/43°C
-  5°C/35°C
-  1 bar/6 bar

 **24 H**  QUASAR 130C AIR COOLED

°C °F	10° 50°	15° 60°	21° 70°	30° 86°
10° 50°	132	125	119	108
21° 68°	119	<b>114</b>	108	99
32° 90°	108	103	99	85
43° 109°	92	85	81	77

### ΜΟΝΤΕΛΑ

												
	(W)	(BTU/h)	(W)43°	(n.)	(mm <sup>2</sup> )	FUSE	100 Kg (kW/h)	(l/h)	(W) (BTU/h)	(Kg)	(Kg) (m <sup>3</sup> )	
QUASAR 130C A		459	1.568	775	2	1,5	10	15	11		95	0,66

